

Complex Configurations
& Tight Spaces

High Speed Performance
- Up to 76 mpm

Reduces
Conveyor Footprint

Ideal for Curves,
Inclines & Declines

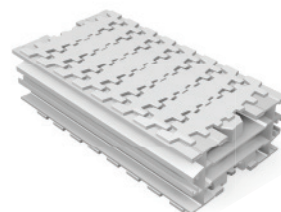
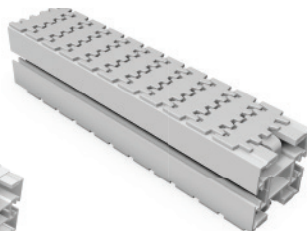
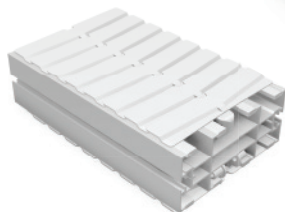
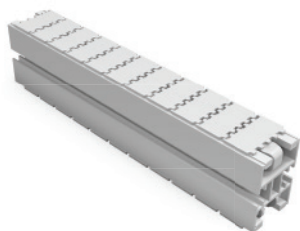

FlexMove®

High Performance, Aluminum, Flexible Chain Conveyors



FlexMove® Conveyors are best for:

- Part Handling
- Transfers
- Tight Spaces
- Elevation Changes
- Accumulation
- Buffering
- Complex Configurations
- Long Lengths
- Cooling & Curing
- Curves, Jogs, Incline, Decline
- Side Grip & Wedge

How to Purchase a FlexMove Conveyor:

Dorner offers a variety of options for purchasing a FlexMove Conveyor based on your application and situation.

FlexMove Components

The modular nature of the FlexMove Conveyor allows experienced users to build their own conveyors. First, order all the necessary parts and components to build your FlexMove Conveyor on site. Using our online configurator, you can design and download CAD drawings. This option will require the proper tools for cutting, bending and installing the conveyor. Consult our installation guide for more details.

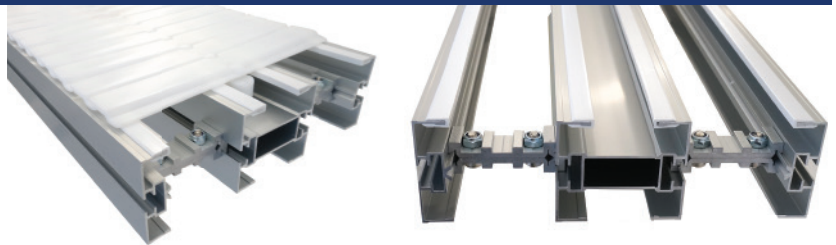

FlexMove Solutions

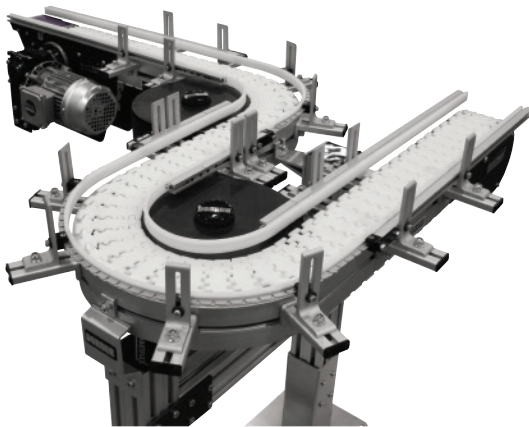

If you do not want to build your own conveyor, a second solution is to have a complete conveyor provided through our FlexMove Solutions. With FlexMove Solutions you can have the conveyor built in our facility, tested, broken down into sub-assemblies and shipped to the end site for installation. With this option, you get exactly what you need without extra components.

FlexMove Assembled On-site

The third solution is to work with Dorner to have your FlexMove Conveyor assembled at the final site. The Conveyor will be purchased similar to option 1, but will be shipped as pre-cut and sized components. The Dorner installation team will then assemble and test the equipment at your location. Contact a Dorner representative for a quote on this service.



Sizes & Measurements

- 45 mm, 65 mm, 85 mm, 105 mm, 150 mm, 180 mm & 260 mm (1.7, 2.5, 3, 4, 6, 7 and 10 in) widths
- 0.6 m to 29.8 m (2 to 98 ft) lengths

Loads & Speeds

- Up to 272 kgs (600 lbs)
- Up to 76 meters (250 feet) per minute

Plastic Chain Types

- Standard: Low Friction & Friction Top Inserts
- Specialty
 - Conductive
 - Cleated
 - Roller Top
 - Magnet Top
 - And Many More

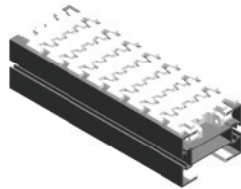

Flat

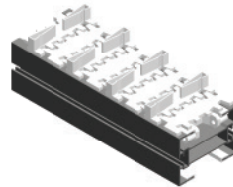

Cleated

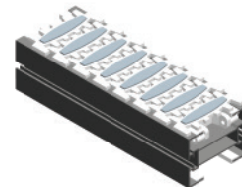

Friction Top

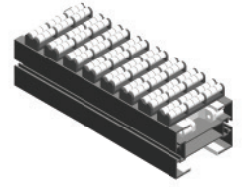

Roller Top

Modules

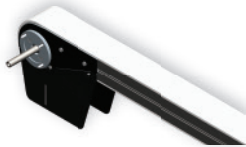

Drive



Idler



Curve
from 15° to 180°



Incline/Decline
from 5° to 90°

Guiding

- Fixed Guide
- Fully Adjustable Single Rail
- Adjustable Double Rail
- And Many More



Transfers

- Industry-Best Transfers
- Multiple Mounting Options
- Powered or Roller

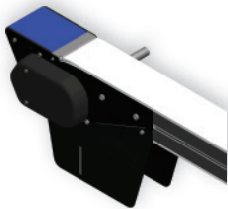

Outfeed / Infeed
Power Transfer

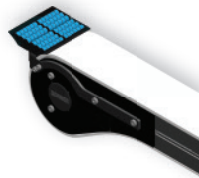

Infeed / Outfeed
Roller Transfer

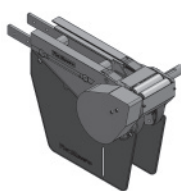

Infeed/Outfeed
Transfer Bridge

Support Stands

- Single, Double and Multi Lane Structures
- Horizontal, Vertical and Angled Mounting Brackets
- Drive End Supports

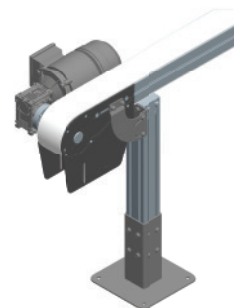
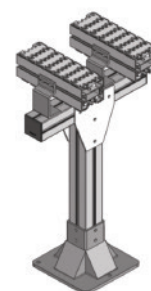
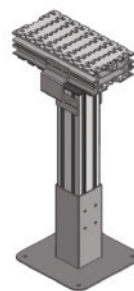

Drives

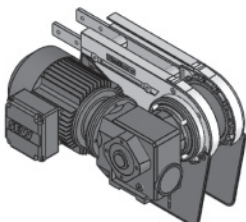

Direct Drive

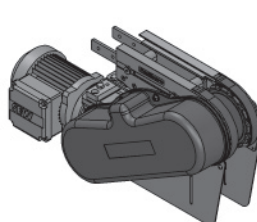

Suspended Drives

Gearmotors

- Standard Load & Heavy Load Options

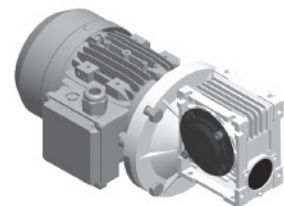

FlexMove Standard Conveyors

- The modular design of the FlexMove Conveyor along with the building blocks of drive, corner, vertical bend, etc. provide unlimited possibilities for conveyor configurations and applications.

Alpine Conveyors

- Ideal for inclines and declines in tight spaces
- Provides capability for vertical incline with minimal floor space
- Applications include accumulating, buffering and cooling product between processes or machines
- Serves as an in-line accumulator with entry and exit at different levels or an in-line or off-line accumulator with entry and exit at the same level



Helix Conveyors

- Reduces conveyor footprint saving valuable floor space
- Allows incline or decline through corners and straights
- Patented side roller chain reduces corner friction
- Provides capability for product buffering or storage for accumulation or cooling
- Provides capability for vertical incline with minimal floor space use
- Simple, low cost Spiral for small parts handling



Helical Curve



Spiral

Wedge Elevators



- Specialty chain designed to securely convey a product by gripping the sides
- Saves footprint space by vertically lifting or lowering a product
- Built with aluminum and stainless steel to meet the stringent hygiene standards required for medical and cosmetic packaging

Top Running Loops & Pallet Systems

- Continuous conveyor loop
- Mid drive module driving on single belt tooth (Includes belt hold down rollers)
- 9 m (30 ft) max total conveyor length
- Patented top running drive design
- Also available using wheel corner drive modules





Industry Best Product Transfers

- Powered transfers allow for smooth end transfers for products as small as 76 mm (3 in) in diameter. They are slave driven off of the conveyor and can be attached to the infeed or exit.

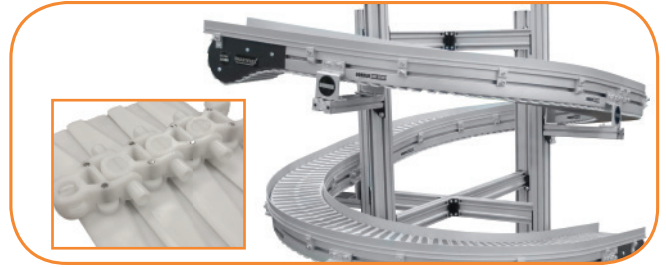

Helical Curve & Spiral Chain

- Patented side roller chain reduces corner friction allowing for multiple turns while maintaining loads and speeds.

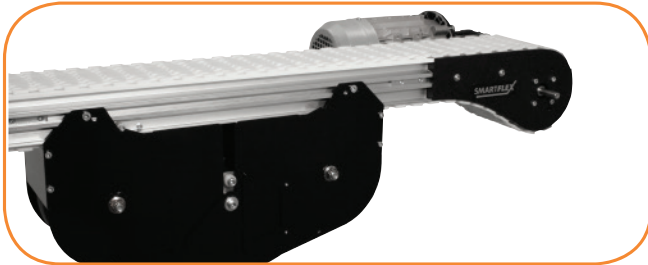

Weighted Take-up Module

- The unique, compact weighted take up is designed to prevent catenary sag and eliminate potential pinch points for safety.



Twist Conveyors

- Easily rotate packages 90 degrees without product change-over with the flexibility of Twist Conveyors.

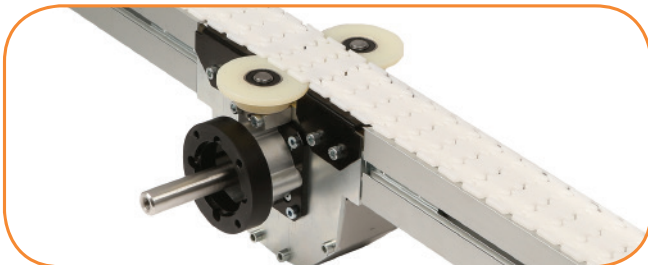

Top Running Loop Drive Design

- The continuous loop features a patented top running drive design for added strength, flexibility, and load capabilities.



Online Configurator

- Engineer simple or complex conveyors to meet your needs in minutes. The industry leading tool delivers a complete 3D CAD assembly model for instant validation of fit.

The Benefits of a Dorner FlexMove® Series Conveyor

Reduces Costs

- Available pre-assembled to your exact specifications; saving labor costs
- FlexMove Solutions eliminates unnecessary cutting, inventory and waste
- Industry leading product transfers eliminate costly product jams, bottlenecks, and damage

Saves Time

- Dorner's online configurator engineers simple or complex conveyors to meet your needs in minutes
- The industry leading tool delivers a complete 3D CAD assembly model for instant validation of fit

Delivers Fast

- Dorner sets the industry standard for delivery
- FlexMove is shattering the norm with conveyors available to ship in as little as 5 working days

Transforming Conveyor Automation

Industrial & Automation Conveyors

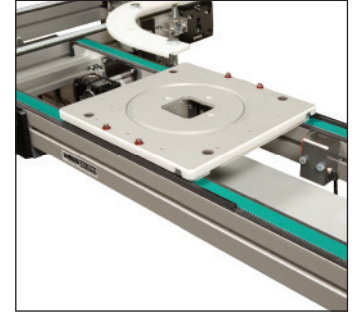
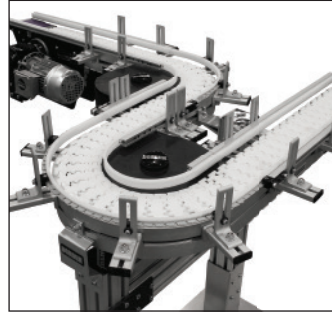
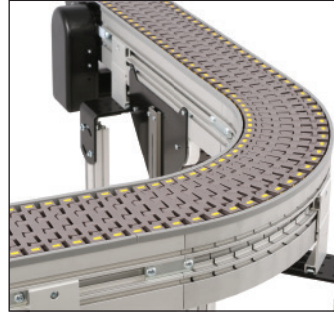

Sanitary Conveyors

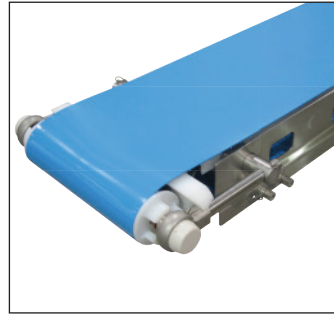
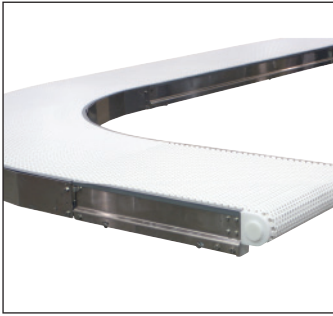

Engineered Solutions

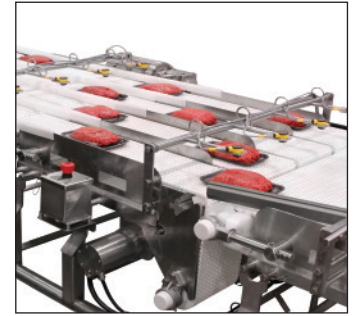
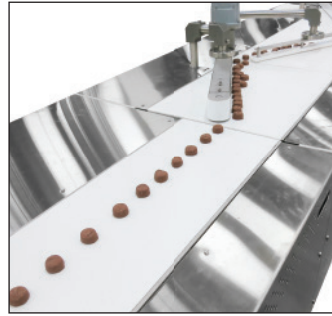

Parts



Service



Online Configurator



Warranty

Dorner – North & South America

Dorner – U.S.A. Headquarters

975 Cottonwood Ave
Hartland, WI 53029, USA
(800) 397-8664
(262) 367-7600
info@dorner.com

Dorner – Canada

100-5515 North Service Road
Burlington, Ontario L7L 6G6
Canada
(289) 208-7306
info@dorner.com

Dorner – Latin America

Carretera a Nogales #5297, Nave 11.
Parque Industrial Nogales
Zapopan, Jalisco C.P. 45222 México
+52.33.30037400
info.latinamerica@dorner.com



Dorner – Europe

Dorner – Germany

Karl-Heinz-Beckurts-Straße 7
52428 Jülich, Germany
+49 (0) 2461/93767-0
info.europe@dorner.com

Dorner – France

8-10 Rue de Nieuport
78140 Vélizy-Villacoublay,
France
+33 (0)1 84 73 24 27
info.france@dorner.com

Dorner – Asia

128 Jalan Permatang Damar Laut, Bayan Lepas 11960
Penang, Malaysia
+604-626-2948 | info.asia@dorner.com



www.dornerconveyors.com